







20 002 706

- avec structure CASCADE
- diamètre de percement 32 mm
- avec marquage chaud
- rosace 60 x 60 mm



	Platine brossé	20 002 706-06
	Chrome	20 002 706-00
	Dark Chrome	20 002 706-19
	Champagne brossé (Or 22cts)	20 002 706-46
	Champagne (Or 22cts)	20 002 706-47
	Dark Platinum brossé	20 002 706-99

20 002 706

mm [inches]

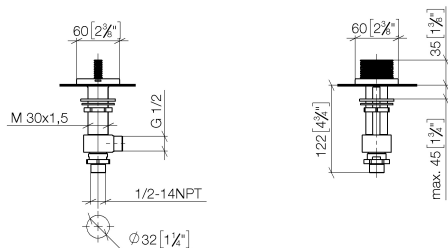

### Diagramme de débit

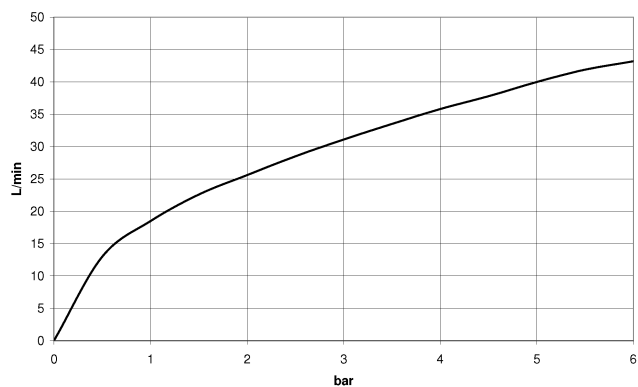

### Certificats

IAPMO\_4976 (5). WRAS\_2103001. LGA\_28688.

20 002 706

Les pièces pour les  
autres finitions  
peuvent être  
trouvées ici : Chrome

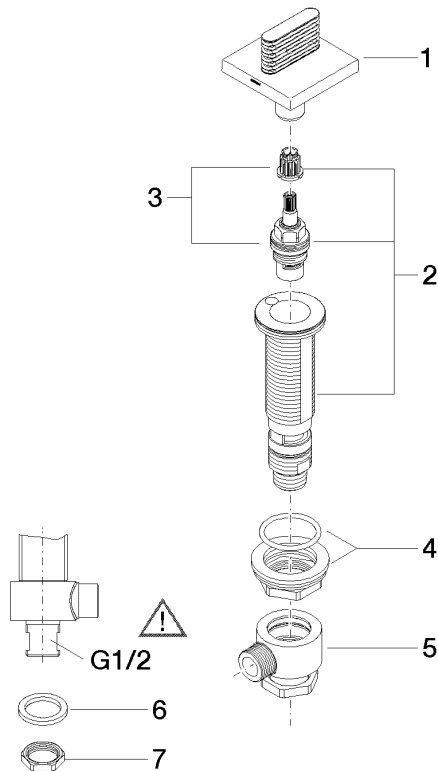

### Liste des pièces de rechange

N°	Article Numéro	Désignation	Fréquence de montage	Délai de livraison
1	90 20 70 053 05-06	poignée ( hot )	1	10
2	04 17 11 058 32 90	partie latérale	1	2
3	90 90 03 132 00 90	tête céramique	1	2
4	04 23 10 032 78 90	set de fixation	1	2
5	04 17 11 023 10 90	raccord multiple	1	2
6	90 23 30 040 00-06	joint américain	1	10
7	09 30 11 059 90	rondelle	1	2
8	09 23 10 012 90	écrou	1	2